



**Skillco Star**  
Industries

Address:  
Airport Road, P.O Gohad Pur,  
Sialkot - Pakistan

Tel: +92-52 4260961  
Mob: +92-300-6178879

Email: [info@skillcostar.com](mailto:info@skillcostar.com)  
Web: [www.skillcostar.com](http://www.skillcostar.com)

## Introduction



Skillco Star Industries is the leading company in the region has been manufacturing and distributing the high quality Surgical, Dental, Veterinary instruments and Fly Fishing Tools since 1991, and have gained a worldwide reputation for excellence. With a tradition of uncompromised quality and adherence to the most stringent standards Skillco Star Industries surgical stands behind every instrument with reputation of EXCELLENCE and International standards in compliance with

**ISO 9001:2008**  
**ISO 13485:2003**  
**CE- Marking**

Doing business with Skillco Star Industries is hassle-free with team of dedicated highly skilled employees in production, administration are responsible for the continuing success of the Skillco Star Industries Organization. Quality is not an accident it is achieved as a result of continuous efforts new inputs to system and human resources. Quality requires a solid foundation through expertise of the people who work for us. That's why we put emphasis in production and training.

We present this smart Surgical,Dental instruments catalogue with a hope that it would be an excellent guide to all our promoters and surgical dental instruments related professionals all over the world. Although this catalogue doesn't cover all the range of surgical,dental instruments yet it assures you that we can make every type of the instruments.So we will also welcome your inquiries for the instruments not listed in this catalog.

Thanks & Regards  
Skillco Star Industries

Address:  
Airport Road, P.O Gohad Pur,  
Sialkot - Pakistan

Tel: +92-52 4260961



+92-300-6178879

[www.skillcostar.com](http://www.skillcostar.com)  
[info@skillcostar.com](mailto:info@skillcostar.com)

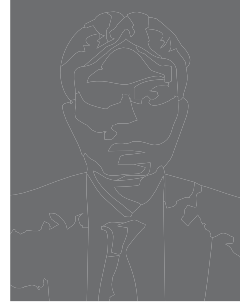

**Mr Abdul Razzaq**  
**(C.E.O)**



# Index

<b>A</b>			
American Pattern Umbilical (Scissors)	06	Dietrich (Atrauma Hemostatic/Cardiovascular Forceps)	59
Aufricht (Scissors)	07	De Bakey (Atrauma Tissue Forceps)	60
American Pattern Allis (Tissue Forceps)	22	<b>E</b>	
Allis (Tissue Forceps)	22	Emmet (Serrated Dissecting Forceps)	14
Adson (Self Retaining Retractors)	32	Echlin (Bone Rongeurs)	56
Amniotome (Obstetrics Instruments)	52	<b>F</b>	
<b>B</b>		Favaloro (Scissors)	10
Braun Stadler Episiotomy (Scissors)	06	Fine Curved (Dissecting & Ligature Forceps)	16
Bonney (Serrated Dissecting Forceps)	13	Fraser-Kelly Crile (Haemostats Forceps)	23
Bickford (Serrated Dissecting Forceps)	13	Fraser - Adson (Haemostats Forceps)	23
Baby-Adson (Dissecting & Ligature Forceps)	17	Finson (Self Retaining Retractors)	34
Beckmann-adson (Self Retaining Retractors)	32	French Model Pelvimeter (Obstetrics)	52
Berkeley Abdominal (Self Retaining Retractors)	36	Finocchio (Rib Spreaders)	58
Burke (Cervical Biopsy Forceps)	51	Finocchio-Baby (Rib Spreaders)	58
Barnes (Obstetrics Instruments,Uterine Cannulae)	52	<b>G</b>	
<b>C</b>		Gillies (Needle Holders)	20
Crafoord (Scissors)	05	Gillies ("Tc" Needle Holders)	30
Chaput Poirier (Tissue Forceps)	25	Gelpi Vulva (Self Retaining Retractors)	34
Crile (Haemostats Forceps)	25	Goligher (Self Retaining Retractors)	36
Cone (Self Retaining Retractors)	33	Grave (Vaginal Speculum)	47
Cusso (Vaginal Speculum)	46	Gluck (Bone & Rib Shears)	57
Cusco Speculum (Vaginal Speculum)	46	Graeme Anderson (Proctology)	50
Collier And Morris (Bone Scoops)	53	Gabriel Rectal Speculum (Proctology)	50
Cooley (Atrauma Tissue Forceps)	60	<b>H</b>	
Cooley (Atrauma Cardiovascular Forceps)	61	Hegemann's Delicate (Scissors)	07
Czerny Rectal Speculum (Proctology)	50	Heymann Turbinectomy (Delicate Scissors)	09
<b>D</b>		Hedgeman Dietrich (Scissors)	10
Dressing (Scissors)	04	Heaney (Needle Holders)	20
Dissecting (Serrated Dissecting Forceps)	11,12	Hoesel ("Tc" Needle Holders)	28
Debakey Very Delicate ("Tc" Needle Holders)	30	Heaney ("Tc" Needle Holders)	29
Deaver (Hand Held Retractors)	42	Henderson (Self Retaining Retractors)	33
Doyen (Intestinal Clamps)	45	Hand Held Retractors	41
Doyen Kocher (Intestinal Clamps)	45	Hartmann (Bone Rongeurs)	54
Doyen Mayo Robson (Intestinal Clamps)	45	Heanley (Bone Rongeurs)	55
Doyen (Vaginal Speculum)	49		
De Bakey-rankin (Atrauma Hemostatic/cardiovascular Forceps)	59		
		<b>I</b>	
		Iris (Delicate Scissors)	08
		Irwin (Self Retaining Retractors)	36
		Israel (Hand Held Retractors)	40
		I.U.D. Removing Hook (Obstetrics Instruments)	52
		<b>J</b>	
		Jameson (Needle Holders)	20
		Jud-allis (Tissue Forceps)	21
		Julian ("Tc" Needle Holders)	26
		Jefferson (Self Retaining Retractors)	33
		Janson Shea (Self Retaining Retractors)	33
		Joll Thyroid (Self Retaining Retractors)	35
		Jacobson (Bone Scoops)	53
		<b>K</b>	
		Kilner (Scissors)	07
		Kilner (Needle Holders)	20
		Kocher (Haemostats Forceps)	24
		Kelly-Crile (Haemostats Forceps)	25
		Kristelle (Vaginal Speculum)	48
		Kogan Endocervical (Vaginal Speculum)	49
		Kelly Proctoscope (Proctology)	50
		Killearn (Bone Rongeurs)	55
		Kielland (Obstetrics Instruments)	52
		<b>L</b>	
		Lloyd Davis Rectal (Scissors)	05
		Ligature Forceps (Dissecting & Ligature Forceps)	17
		Littlewood (Tissue Forceps)	21
		Lloyd Davis (Haemostats Forceps)	24
		Lloyd Davis (Hand Held Retractors)	39
		Lane Twin Anastomosis (Intestinal Clamps)	43
		Lloyd Davis Rectal Occlusion (Intestinal Clamps)	44
		Lempert (Bone Scoops)	53
		Leksell (Bone Rongeurs)	55

<b>M</b>			
<b>Mayo</b> (Scissors)		01	
<b>Mayo Harrington</b> (Scissors)		02	
<b>Mayo Harrington</b> (Scissors)		02	
<b>Mayo Stille</b> (Scissors)		02	
<b>Metzenbaum</b> (Scissors)		03	
<b>Metzenbaum Nelson</b> (Scissors)		03	
<b>Maingot Intestinal Emmet</b> (Serrated Dissecting Forceps)		14	
<b>Macindoe</b> (Delicate Dissecting Forceps)		15	
<b>Micro Adson</b> (Dissecting & Ligature Forceps)		17	
<b>Moynihan</b> (Haemostats Forceps)		18	
<b>Mixter</b> (Haemostats Forceps)		18	
<b>Mayo</b> (Haemostats Forceps)		24	
<b>Mathieu</b> ("Tc" Needle Holders)		27	
<b>Mathieu-standard</b> ("Tc" Needle Holders)		28	
<b>Millin Retropubic</b> (Self Retaining Retractors)		35	
<b>Mathieu</b> (Vaginal Speculum)		49	
<b>Modified Wertheim</b> (Vaginal Speculum)		49	
<b>Macewen</b> (Bone Scoops)		53	
<b>Martini</b> (Bone Scoops)		53	
<b>Mead</b> (Bone Rongeurs)		54	
<b>N</b>			
<b>Negus Tonsil</b> (Tonsil Artery Forceps)		19	
<b>Naunton Morgan</b> ("Tc" Needle Holders)		29	
<b>Northfield</b> (Bone Rongeurs)		54	
<b>Northfield</b> (Bone Rongeurs)		56	
<b>O</b>			
<b>Ochsner</b> (Atrauma Hemostatic/Cardiovascular Forceps)		59	
<b>P</b>			
<b>Potts</b> (Scissors)		10	
<b>Plester-lansen</b> (Self Retaining Retractors)		31	
<b>Pederson</b> (Vaginal Speculum)		47	
<b>Pratt Rectal Speculum</b> (Proctology)		50	
<b>R</b>			
<b>Ramsey</b> (Serrated Dissecting Forceps)		13	
<b>Resano</b> (Intestinal Clamps)		44	
<b>S</b>			
<b>Stevens Tenotomy</b> (Delicate Scissors)		09	
<b>St Marks Emmet</b> (Serrated Dissecting Forceps)		14	
<b>S.shaped Delicate</b> (Dissecting & Ligature Forceps)		17	
<b>Schmidt Tonsil</b> (Tonsil Artery Forceps)		19	
<b>St Marks Hospital Perineal</b> (Self Retaining Retractors)		35	
<b>Smillie Retractors</b> (Hand Held Retractors)		38	
<b>Sims</b> (Vaginal Speculum)		47	
<b>Synovectomy Rongeur</b> (Bone Rongeurs)		54	
<b>T</b>			
<b>Toennis</b> ("Tc" Needle Holders)		26	
<b>Turner Warwick</b> (Self Retaining Retractors)		34	
<b>Turner Warwick Retractor Blades</b> (Self Retaining Retractors)		37	
<b>SIMS RECTAL SPECULUM (Proctology)</b>		50	
<b>Townsend</b> (Cervical Biopsy Forceps)		51	
<b>Trotter</b> (Bone Rongeurs)		55	
<b>U</b>			
<b>Uterine</b> (Scissors)		05,06	
<b>V</b>			
<b>Volkman</b> (Bone Scoops)		53	
<b>Vacume Extraction Suction Head</b> (obstetrics Instruments)		52	
<b>W</b>			
<b>Waugh</b> (Delicate Dissecting Forceps)		15	
<b>Wilson Tonsil</b> (Tonsil Artery Forceps)		19	
<b>Wright</b> (Needle Holders)		20	
<b>Walace Modified Plester-lansen</b> (Self Retaining Retractors)		31	
<b>Wrigley</b> (Obstetrics Instruments,Uterine Cannulae)		52	
<b>Z</b>			
<b>Zweifel</b> ("Tc" Needle Holders)		27	
<b>Zaufal-Jansen</b> (Bone Rongeurs)		56	

# Scissors



**MAYO**  
**SSI-3074**  
Favaloro 132mm (6")  
Shanks curved.  
blades angled to side



**Mayo Scissors Str**  
**SSI- 10.0052.14**  
14.5cm  
15cm  
16cm  
17cm  
19cm  
23cm



**Mayo Scissors Cvd**  
**SSI- 10.0053.14**  
14.5cm - 15cm  
16cm - 17cm  
18cm - 19cm  
23cm



**Mayo Harrington Operating**  
**SSI- 10.0058.22**  
str 22.5cm  
30cm



**Mayo Harrington  
Operating Scissors**  
SSI- 10.0059.22  
cvd 22.5cm  
30cm



**Mayo Stille Scissors**  
SSI- 10.0064.16  
str 16cm 19cm  
21cm

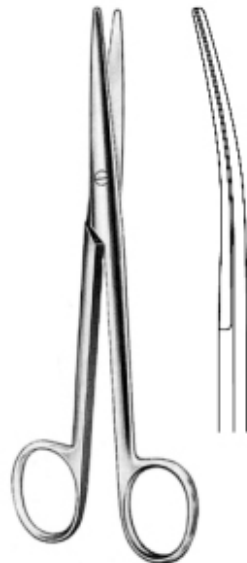

**Mayo Stille Scissors**  
10.0065.16  
cvd 16cm  
19cm  
21cm



**Mayo Stille Scissors**  
SSI- 10.0068.15  
str 15cm  
17cm  
21cm



**Mayo Stille Scissors**  
SSI- 10.0069.15  
cvd 15cm  
15cm  
17cm  
21cm



**Mayo Noble Scissors**  
**SSI- 10.0072.17**  
str 17cm



**Mayo Noble Scissors**  
**SSI- 10.0073.17**  
cvd 17cm



**Operating Scissors**  
**SSI- 10.0010.10**  
Op-Scissors bl/bl str 10.5cm  
11.5cm  
13.0cm  
14.5cm  
15.5cm  
16.5cm  
18.0cm  
20.0cm

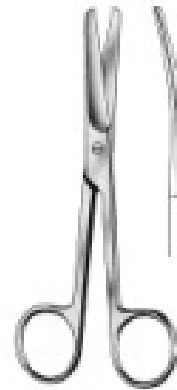

**Operating Scissors**  
**SSI- 10.0011.10**  
Op-Scissors bl/bl cvd 10.5cm  
11.5cm  
13.0cm  
14.5cm  
15.5cm  
16.5cm  
18.0cm  
20.0cm



**Operating Scissor**  
**SSI- 10.0012.10**  
Op-Scissors sh/bl str 10.5cm  
11.5cm  
13.0cm  
14.5cm  
15.5cm  
16.5cm  
18.5cm  
20.0cm



**Operating Scissor**  
**SSI- 10.0012.10**  
sh/bl cvd 10.5cm  
11.5cm  
13.0cm  
14.5cm  
15.5cm  
16.5cm  
18.5cm  
20.0cm

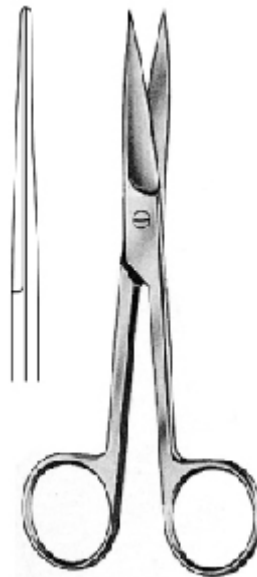

**Operating Scissor**  
**SSI- 10.0014.10**  
sh/sh str 10.5cm  
11.5cm - 13.0cm  
14.5cm - 15.5cm  
16.5cm - 18cm  
20cm



**Operating Scissor**  
**SSI- 10.0015.10**  
sh/sh cvd  
15.5cm  
16.5cm  
18cm  
20cm



# Scissors



**Grazil Operating Scissor**  
**SSI- 10.0022.13**  
bl/bl str 13cm  
14.5cm



**Grazil Operating Scissor**  
**SSI- 10.0023.13**  
bl/bl cvd 13.0cm  
13.0cm 14.5cm



**Grazil Operating Scissor**  
**SSI- 10.0024.13**  
sh/bl str 13.0cm  
14.5cm



**Busch Umbilical Scissors**  
**SSI- 10-2501-01**  
CURVED 16.0 CM 6 1/4"

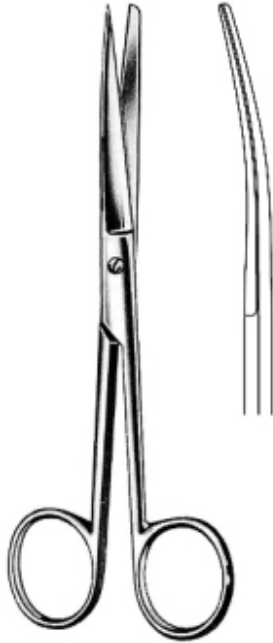

**Grazil Operating Scissor**  
**SSI- 10.0025.13**  
sh/bl cvd 13.0cm  
14.5cm

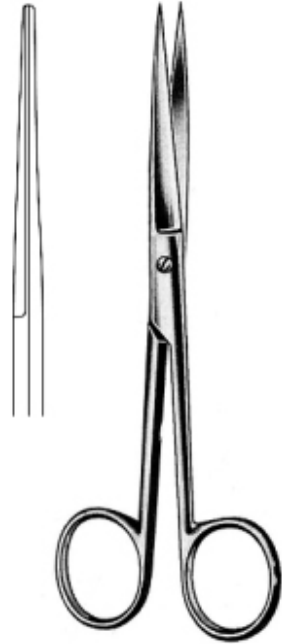

**Grazil Operating Scissor**  
**SSI- 10.0026.13**  
sh/sh str 13.0cm  
14.5cm

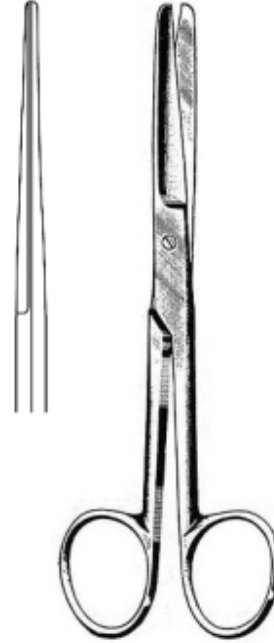

**Deaver Scissors**  
**SSI- 10.0034.14**  
str bl/bl 14cm



**Deaver Scissors**  
**SSI- 10.0035.14**  
cvd bl/bl 14cm

## Scissors



**Braun Stadler Episiotomy**  
**SSI- 3046**

Angled Blades  
14cm  
18cm



**Metzenbaum Scissor**  
**SSI- 3070**

Straight, blunt points  
115mm 4.1/2", 145mm 5.3/4"  
180mm 7", 200mm 8"



**Metzenbaum Scissor**  
**SSI- 3074**

(Nelson) 230mm 9"  
250mm 10" Straight



**Lister Bandage Scissors**  
**SSI- OD-001**

18.5cm / 7 1/4" 20cm / 8"



**Esmarch Plaster**  
**Shears**

**SSI- OD-002**  
Heavy Pattern  
Short Blades



**IRIS**  
110mm (4.1/2")  
sharp points

**3058**  
Straight

**3059**  
Curved on flat

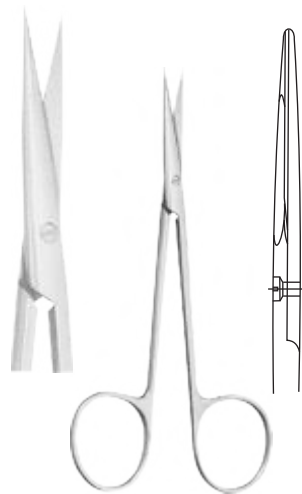
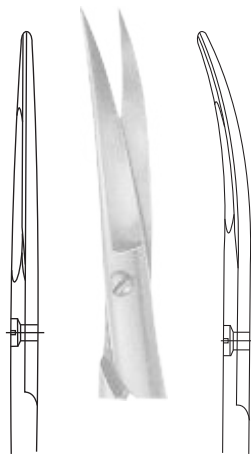

**IRIS**  
110mm (4.1/2")  
Round blades, sharp points

**3060**  
Straight

**3061**  
Curved on flat

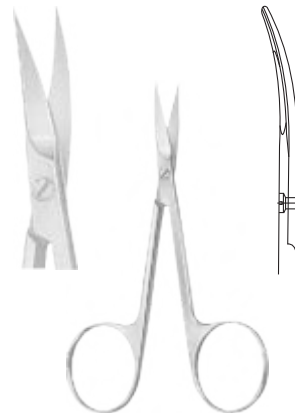

**IRIS**  
**3062**  
90mm (3.1/2")  
Curved on flat, lightweight  
sharp points

## Delicate Scissors



**HEYMANN  
TURBINECTOMY**

**3063**  
185mm (7.1/4")  
Angled shanks  
blunt points



**STEVENS TENOTOMY**  
110 mm (4.1/4")

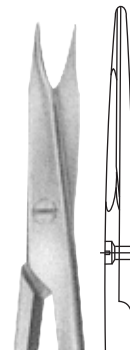

**3064**  
straight,  
sharp points

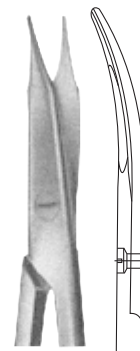

**3065**  
Curved on flat  
sharp points



**POTTS**

**3066**

190mm (7.1/2")  
Angled on flat 45 degrees

**3067**

190mm (7.1/2")  
Angled on side 25 degrees

**3068**

190mm (7.1/2")  
Angled on side 45 degrees

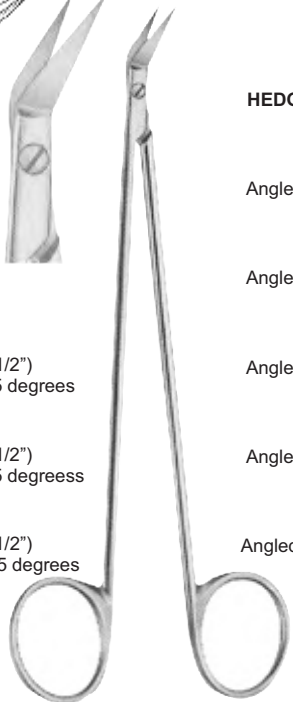

**HEDGEMAN (DIETRICH)**

**3069**

175mm (7")  
Angled to side, 25 degrees

**3070**

175mm (7")  
Angled to side, 45 degrees

**3071**

175mm (7")  
Angled to side, 60 degrees

**3072**

175mm (7")  
Angled to side, 90 degrees

**3073**

175mm (7")  
Angled to side, 125 degrees



**FAVALORO**

**3074**

132mm (6")  
Shanks curved,  
blades angled to side

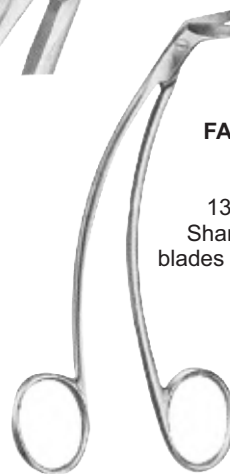

# Serrated Dissecting Forceps



**DISSECTING  
FORCEPS**



**3075**  
115mm  
(4.1/2")



**3076**  
130mm  
(5.1/8")



**3077**  
145mm  
(5.3/4")



**3078**  
160mm  
(6.1/4")



**3079**  
305mm  
(12")



**DISSECTING  
FORCEPS**



**3080**  
132mm  
(6")



**3081**  
180mm  
(7")



**3082**  
200mm  
(8")



**DISSECTING  
FORCEPS**  
Round Points



**3083**  
115mm  
(4.1/2")



**3084**  
130mm  
(5.1/8")



**3085**  
132mm  
(6")



**3086**  
160mm  
(6.1/4")



**3087**  
180mm  
(7")



**3088**  
200mm  
(8")



**3089**  
232mm  
(10")



**3090**  
300mm  
(12")



## Serrated Dissecting Forceps



**RAMSEY**

**3091**  
180mm (7")



**BONNEY**

**3092**  
180mm (7")

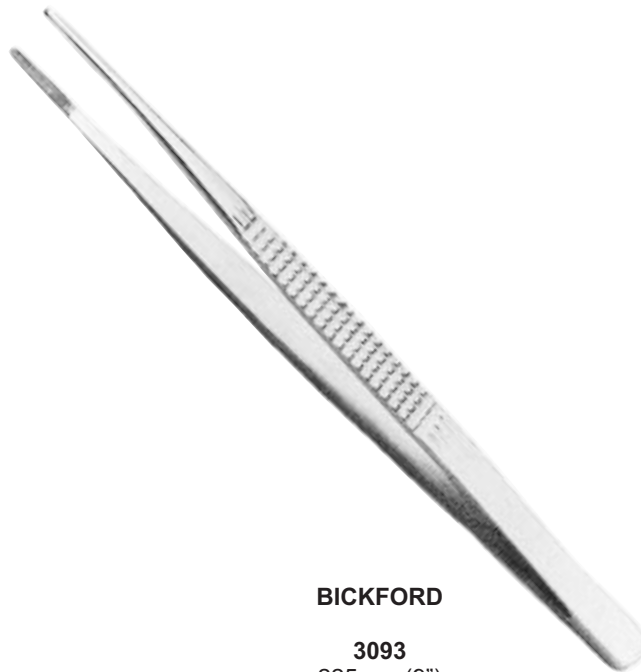

**BICKFORD**

**3093**  
225mm (9")

**MAINGOT INTESTINAL**  
Fenestrated Grip

**3094**  
280mm (11")

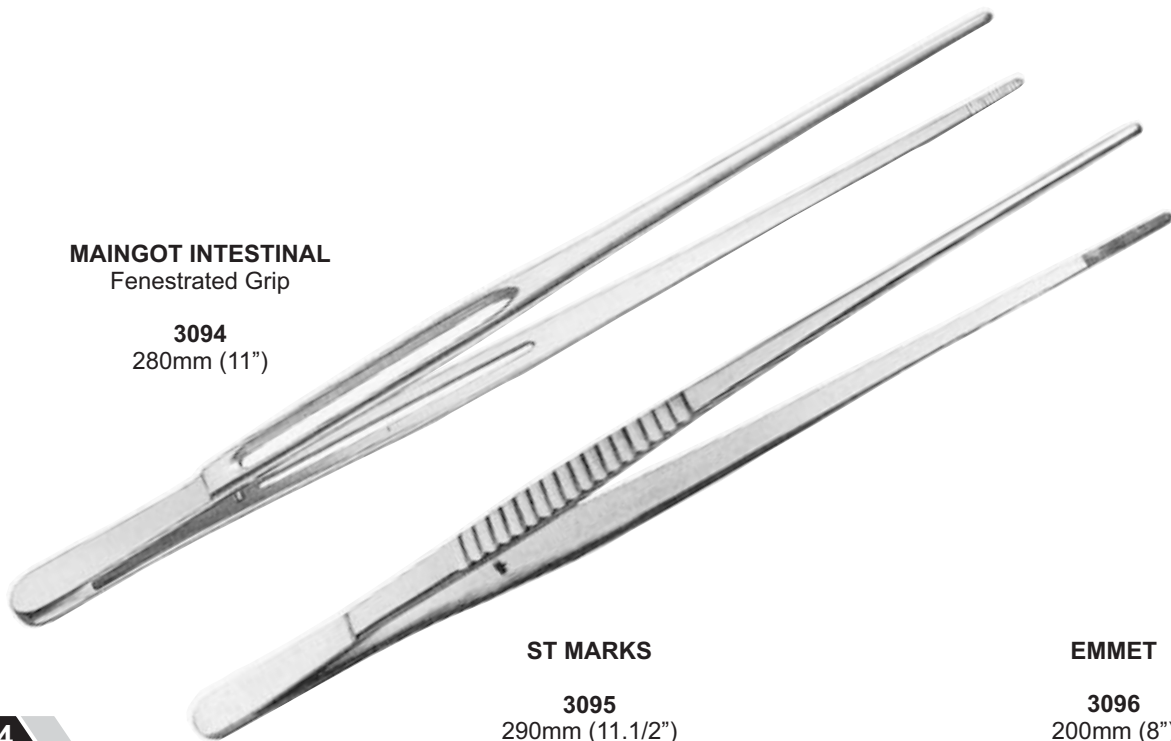

**ST MARKS**

**3095**  
290mm (11.1/2")

**EMMET**

**3096**  
200mm (8")



## Toothed Dissecting Forceps



**SILCOCK**  
**SSI- 3285**  
1x2 teeth 100mm 4"  
110mm 4.3/8"



**FINE**  
**SSI- 3290**  
1x2 teeth  
100mm 4" - 100mm 4"



**RAMSEY**  
**SSI- 3293**  
180mm 7"



**RAMSEY**  
**SSI- 3294**  
180mm 7"



**BONNEY**  
**SSI- 3295**  
1x2 teeth  
180mm 7"



**BICKFORD**  
**SSI- 3296**  
1X2 teeth  
225mm 9"



**CANADIAN**  
**SSI- 3297**  
2x3 teeth  
140mm 5.1/2"  
150mm 6"



**WAUGH**  
**SSI- 3299**

1X2 teeth 150mm 6"  
180mm 7", 200mm 8"



**WAUGH**  
**SSI- 3302**

1x2 teeth  
125mm 5" Fine  
125mm 5" Standard  
190mm 7.1/2"



**ADSON Bayonet**  
**SSI- 3305**

1x2 teeth  
190mm 7.1/2"



**JEFFERSON**  
**SSI- 3306**

1x2 teeth 180mm 7"



**ADSON-BROWN**  
**SSI- 3307**

7X7 teeth 125mm 5"



**PennyBacker**  
**SSI- 3308**

3x4 teeth  
160mm 6.1/2"

## Toothed Dissecting Forceps



**Toothed Dissecting  
SSI- 3309**  
105mm 4.1/8", 115mm 4.1/2"  
130mm 5.1/8", 150mm 6"  
160mm 6.1/4", 180mm 7"  
200mm 8", 250mm 10", 300mm 12"

**LANE  
SSI- 3329**  
1x2 teeth 125mm 5"  
145mm 5.3/4", 180mm 7",  
LANE 2X3 teeth  
145mm 5.3/4", 180mm 7"

**Toothed Dissecting  
SSI- 3318**  
1x2 teeth 115mm 4.1/2"  
130mm 5.1/8"  
145mm 5.3/4", 160mm 6.1/4"

**GILLIES  
SSI- 3322**  
1x2 teeth 150mm 6"

**MICINDOE  
SSI- 3223**  
1X2 teeth 150mm 6"

**Toothed Dissecting  
SSI- 3334**  
150mm 6" 2x3 teeth  
3x4 teeth

**TREVES  
SSI- 3224**  
1X2 teeth 125mm 5"  
150mm 6", 180mm 7"  
200mm 8", 250mm 10"



**3097**  
90mm  
(3.1/2")



**3098**  
105mm  
(4.1/8")



**3099**  
115mm  
(4.1/2")



**3100**  
130mm  
(5.1/8")



**3101**  
145mm  
(5.3/4")



**3102**  
90mm  
(3.1/2")

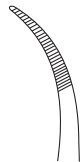

**3103**  
105mm  
(4.1/8")

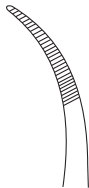

**3104**  
115mm  
(4.1/2")

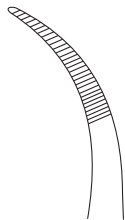

**3105**  
130mm  
(5.1/8")

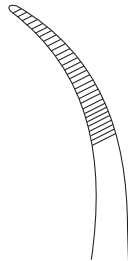

**3106**  
145mm  
(5.3/4")



**MACINDOE**  
**3107**  
132mm (6")



**WAUGH**  
**3108**  
200mm (8")



**WAUGH**



**3109**  
132mm (6")

**3110**  
180mm (7")

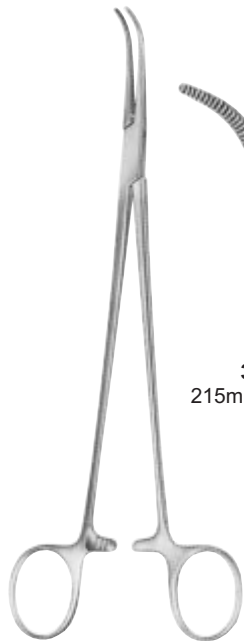

**FINE CURVED DISSECTING  
FORCEPS**

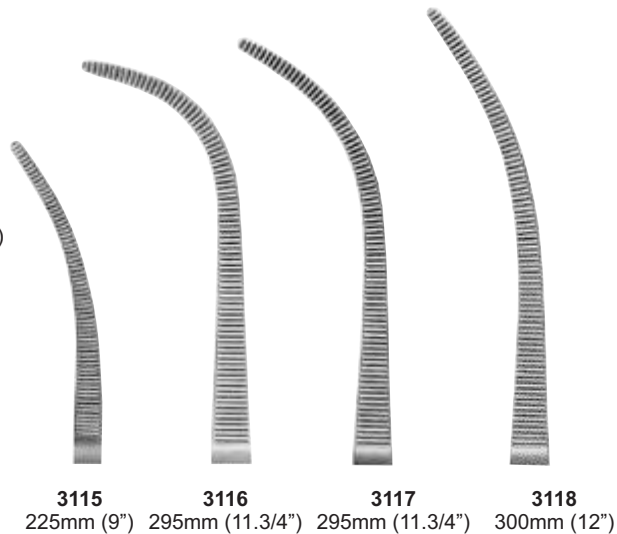
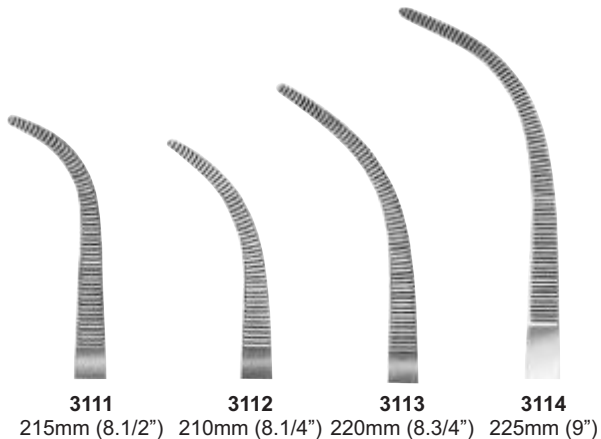

# Dissecting & Ligature Forceps

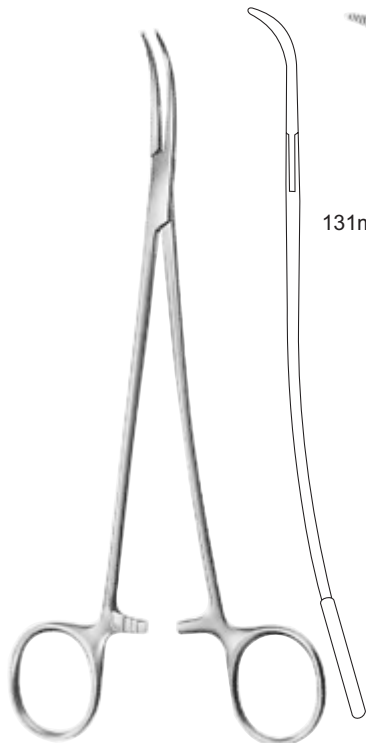

**S.SHAPED DELICATE**



**3119**

131mm (5.1/2")

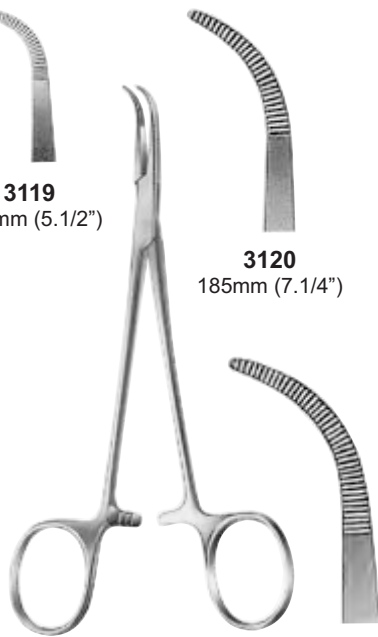

**3120**

185mm (7.1/4")

**3121**

210mm (8.1/4")

**MICRO ADSON**



**LIGATURE FORCEPS**

**3122**

95mm (3.3/4")

Straight, smooth jaw



**3123**

131mm  
(5.1/2")

**3124**

180mm  
(7")

**BABY - ADSON**





**TISSUE FORCEPS**  
SSI- TCNH-3213

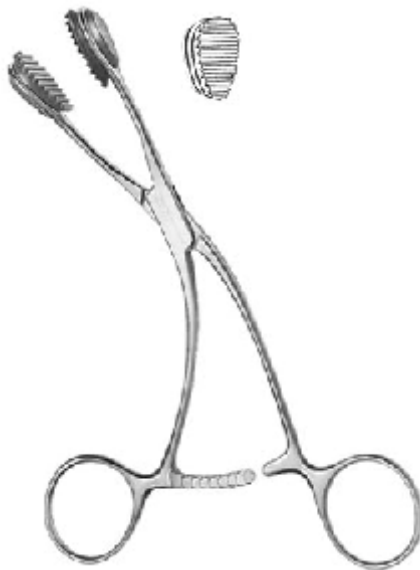

**TONGUE FORCEPS**  
SSI- TCNH-3215



**MOUTH GAGS**  
SSI- TCNH-3214

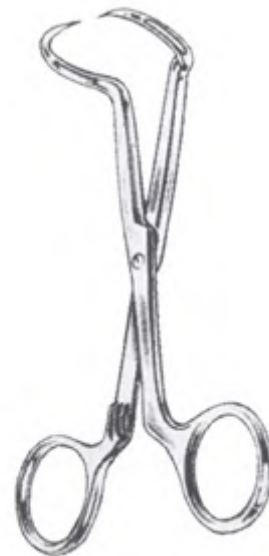

**TONGUE FORCEPS**  
SSI- TCNH-3212

# Dissecting & Ligature Forceps



**SEIZING AND HAEMOSTATIC**  
SSI- TCNH-3211



**NAZAL CUTTING  
FORCEPS**  
SSI- TCNH-3209



**POLYPUS AND DRESSING**  
SSI- TCNH-3208



**POLYPUS AND DRESSING**  
SSI- TCNH-3207

**POLYPUS AND FOREIGN**  
SSI- TCNH-3206



**TOWEL CLAMPS**  
SSI- TCNH-3205



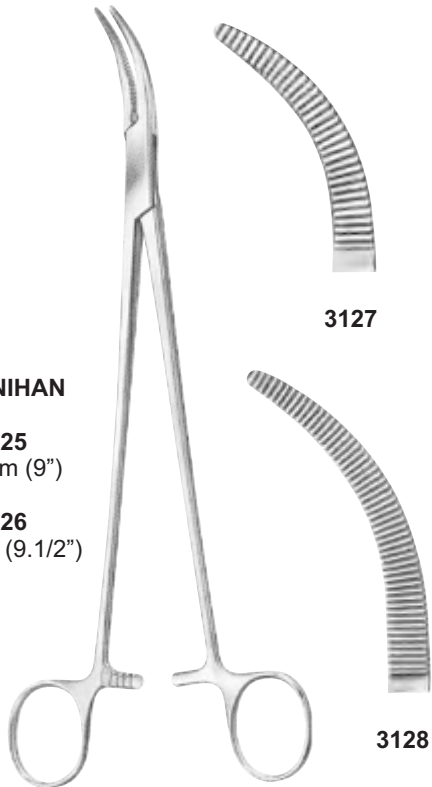

**MOYNIHAN**

**3125**

230mm (9")

**3126**

231mm (9.1/2")

**3127**

**3128**



**MIXTER**  
Curved on flat



**3129**  
131mm (5.1/2")

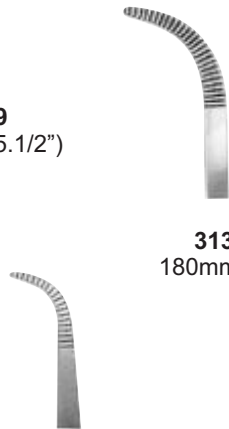

**3131**  
180mm (7")



**3130**  
230mm (9")

# Haemostats Forceps



**FRASER-KELLY (CIRCLE)**  
**SSI- 3156**  
180mm (7")  
Curved on Flat



**Haemostats Forceps**  
**SSI- 3157**  
180mm (7")  
Curved on flat



**Haemostats Forceps**  
**SSI- 3158**  
180mm (7")  
Straight



**Haemostats Forceps**  
**SSI- 3159**  
185mm (7.1/4")  
Curved on flat  
1 \* 2 teeth



**Haemostats Forceps**  
**SSI- 3160**  
185mm (7.1/4")  
Straight  
1 \* 2 teeth



**DUNHILL**  
**SSI- 3161**  
125mm (5")  
Curved on Flat  
31621



**KOCHER**  
**SSI- 3164**  
Curved on Flat 1 \* 2 teeth  
125mm (5")

# Haemostats Forceps



**LLOYD DAVIS**  
**SSI- 3170**  
260mm (10.1/4")  
Curved on flat



**MAYO**  
**SSI- 3171**  
160mm (6.1/4")  
Curved on flat



**CRILE**  
**SSI- 3172**  
1 \* 2 teeth  
160mm (6.1/4")  
Straight

3173  
160mm (6.1/4")  
Curved on Flat  
3174  
131mm (5.1/2")  
Straight  
3175  
131mm (5.1/2")



**CRILE**  
**SSI- 3176**  
Curved on Flat  
131mm (5.1/2")  
3177  
160mm(6.1/4")



**KELLY-CRILE**  
**SSI- 3178**

Straight  
131mm (5.1/2")  
3179  
160mm (6.1/4")



**Halstead Mosquito Forceps**  
**SSI- S20-501**

5" Straight  
5" Straight Delicate  
5" Curved  
5" Curved Delicate



**Rochester Pean Forceps**  
**SSI- S21-958**

5 1/2", 6 1/4", 7 1/2" Straight  
5 1/2", 6 1/4", 7 1/2" Curved  
8" 9" 10" Straight  
8" 9" 10" Curved



**KOCHER FORCEPS**  
**SSI- 3421**

Curved on flat 1x2 teeth 125mm 5"  
140mm 5.1/2", 150mm 6"  
180mm 7", 200mm 8", 225mm 9"



# Tonsil Artery Forceps



**SCHNIDT TONSIL**  
**3132**

180mm (7") Slight curved on flat



**3133**



**3134**



## NEGUS TONSIL

**3135**  
180mm (7")  
Small curved

**3136**  
180mm (7")  
Large curved



## WILSON TONSIL

**3137**  
190mm (7.1/2")  
Curved on flat  
Angled shafts



**WEBSTER  
3491**  
Smooth jaw 115mm 4.1/2"



**LAWRANCE  
3492**  
150mm 6" Lightweight



**LAWRANCE  
3493**  
150mm 6"



**MAYO  
3494**  
150mm 6"

## Needle Holders



**MCPHAIS  
3495**  
180mm 7"



**HALSEY  
3496**  
125mm 5"



**MATHIEU  
3497**  
140mm 5.1/2"



**MATHIEU  
3498**  
170mm 6.3/4"





**MATHIEU**  
**3499**  
200mm 8"



**MAYO (BAUMGARTNER)**  
**3500**  
140mm 5.1/2"



**MAYO (MASSON)**  
**3501**  
265mm 10.1/2"



**MAYO**  
**3502**  
165mm 6.1/2"



**MAYO**  
**3503**  
190mm 7.1/2"

## Needle Holders



**MAYO  
3504**  
200mm 8"



**MAYO  
3505**  
230mm 9"



**HEGAR  
3506**  
200mm 8"

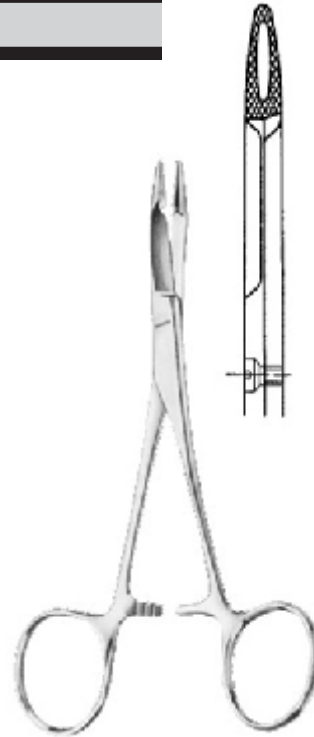

**OLSON HEGAR  
3507**  
Combined needle holder and scissors  
140mm 5.1/2", 165mm 6.1/2" 190mm 7.1/2"

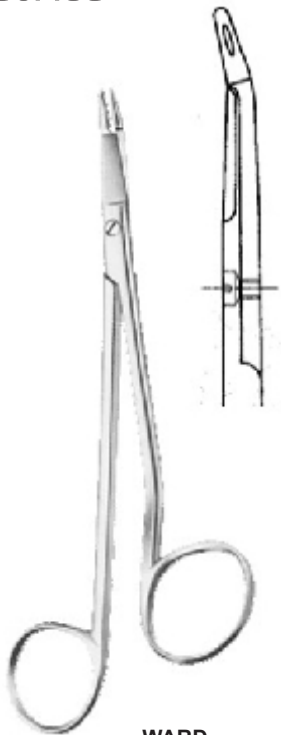

**WARD  
3510**

Combined Needle Holder  
and scissors 180MM 7"

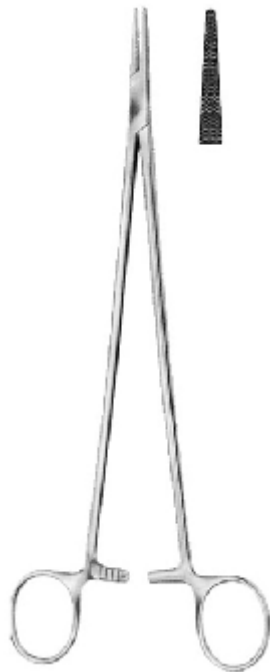

**JAMESON  
3511**

230mm 9"

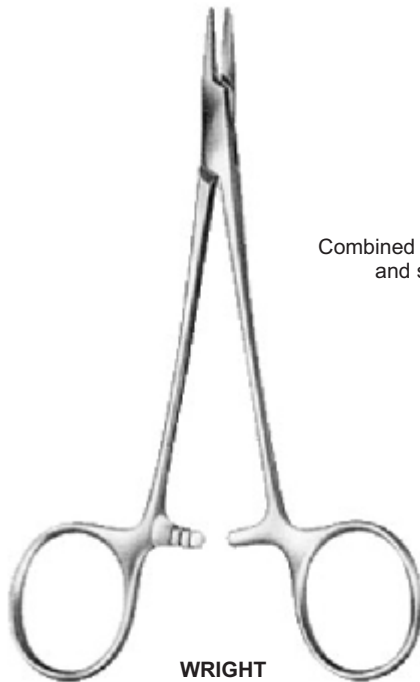

**WRIGHT  
3512**

125mm 5"

Combined needle holder  
and scissors

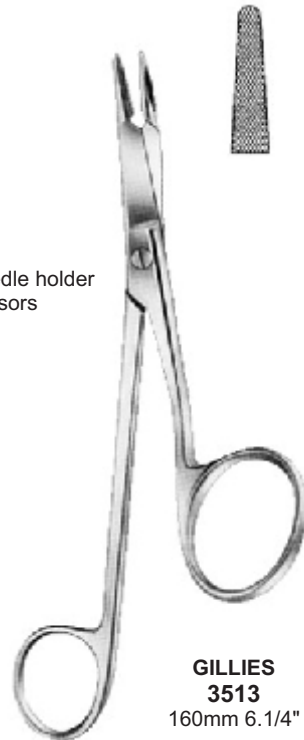

**GILLIES  
3513**

160mm 6. 1/4"

## Needle Holders



**KILNER**  
**3514**  
135mm 5.1/4"



**HEANEY**  
**3515**  
200mm 8"



**CRILE WOOD**  
**3516**  
150mm 6"



**CRILE MURRAY**  
**3517**  
145mm 5.3/4"

**NAUNTON MORGAN**  
**3518**  
90mm 7.1/2"  
250mm 10"

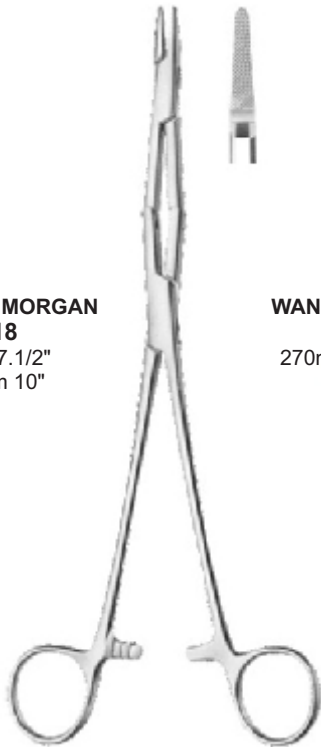

**WANGENSTEEN**  
**3520**  
270mm 10.3/4"



**CONVERSE**  
**3521**  
125mm 5"

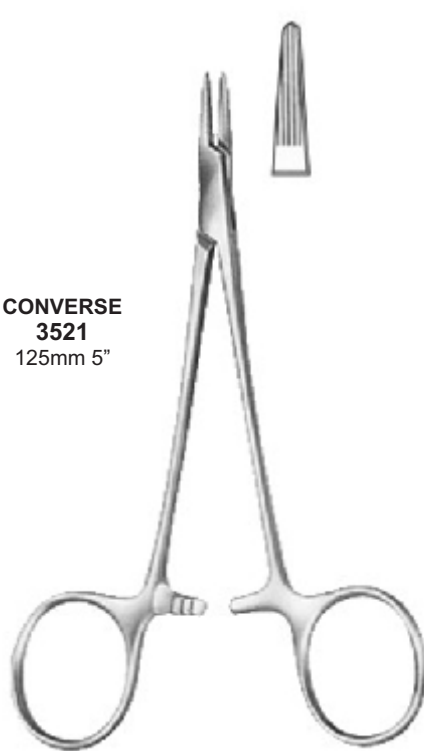



## Needle Holders



**DERF**  
**3522**  
120mm 4.3/4"

**MAYO (DUNHILL)**  
**3523**  
160mm 6.1/4"



**MAYO**  
**3524**  
180mm 7"

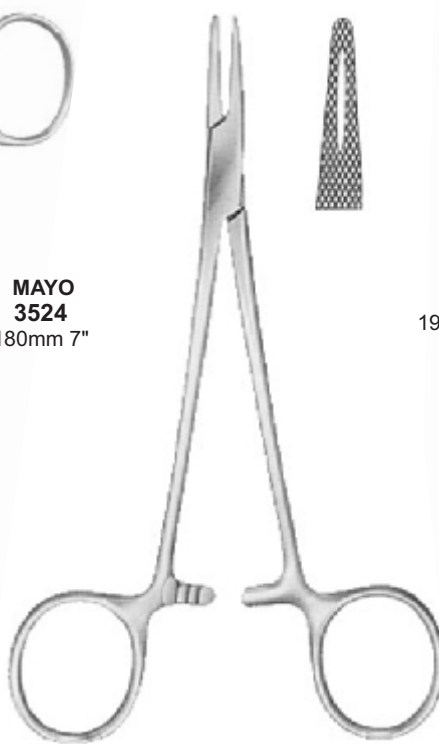

**MAYO**  
**3525**  
190mm 7.1/2"



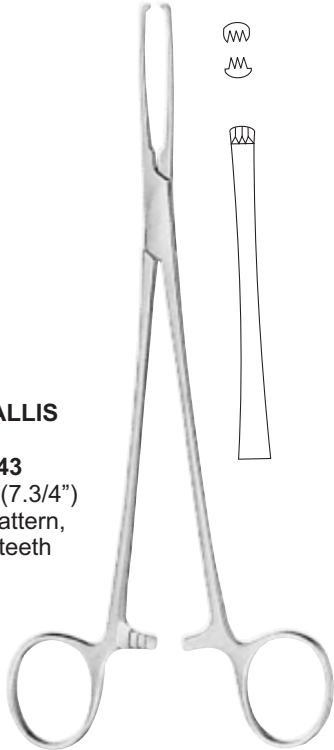

**JUD-ALLIS**

**3143**  
195mm (7.3/4")  
Light pattern,  
3 x 4 teeth



**CHAPUT (POIRIER)**

**3144**  
125mm (5")  
2 x 3 teeth



**LITTLEWOOD**  
**3145**

185mm (7.1/4")  
2 x 3 teeth

# Tissue Forceps

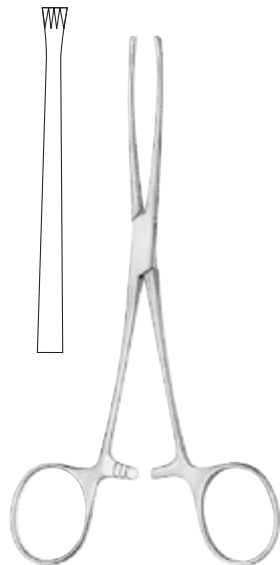

**AMERICAN PATTERN ALLIS**  
**3146**  
132mm (6")  
3 x 4 teeth

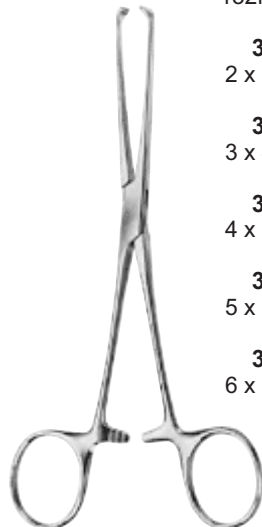

**ALLIS**  
132mm (6")  
**3147**  
2 x 3 teeth  
**3148**  
3 x 4 teeth  
**3149**  
4 x 5 teeth  
**3150**  
5 x 6 teeth  
**3151**  
6 x 7 teeth



**ALLIS**  
**3152**  
190mm (7.1/2")  
**3153**  
255mm (10")  
5 x 6 Teeth



**3154**



**3155**



**PLESTER-JANSEN**  
Right  
**3203**  
131mm (5.1/2")

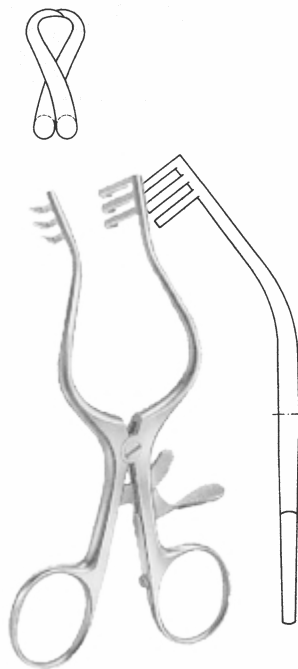

**PLESTER-JANSEN**  
**3204**  
131mm (5.1/2")

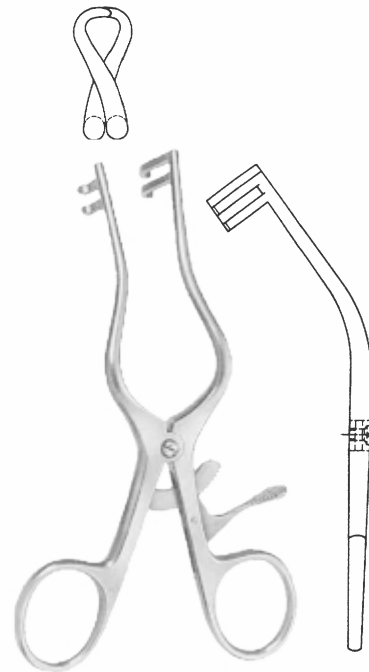

**WALLACE MODIFIED**  
**PLESTER-JANSEN**  
**3205**  
131mm (5.1/2")

# Self Retaining Retractors

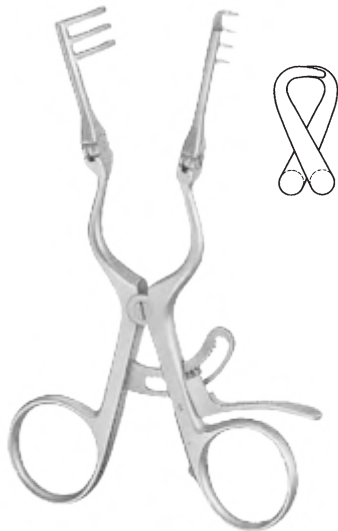

**CONE**

**3209**  
145mm (5.3/4")



**JANSON (SHEA)**

**3210**  
105mm (4.1/8")

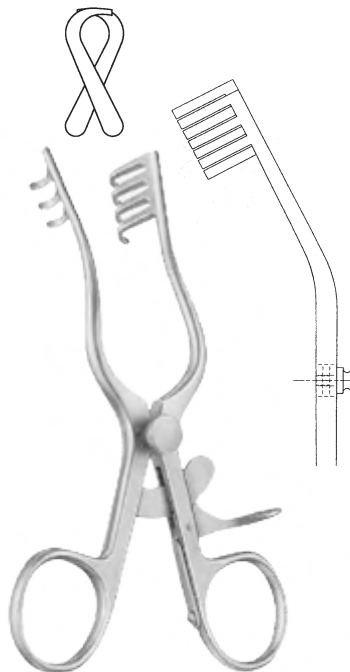

**JEFFERSON**

**3211**  
131mm (5.1/2")



**HENDERSON**

**3212**  
130mm (5.1/8")

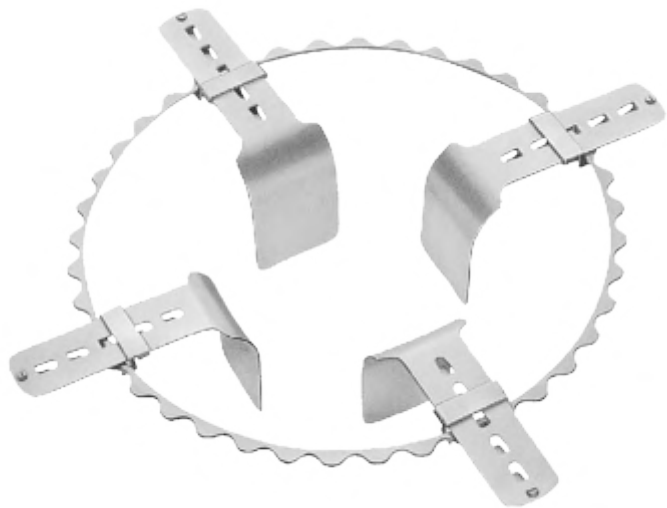

**TURNER WARWICK**

**3213**

131mm x 180mm (7" x 5.1/2")  
Oval sprocket frame and four blades



**GELPI VULVA**  
**3214**

165mm (6.1/2")



**FINSON**

**3215**  
70mm (2.3/4")

## Self Retaining Retractors



**JOLL THYROID**

**3216**  
152mm (6")



**MILLIN RETROPUBIC**

**3217**  
Blades  
55mm x 25mm  
80mm x 25mm

Centre blade:  
115mm x 45mm

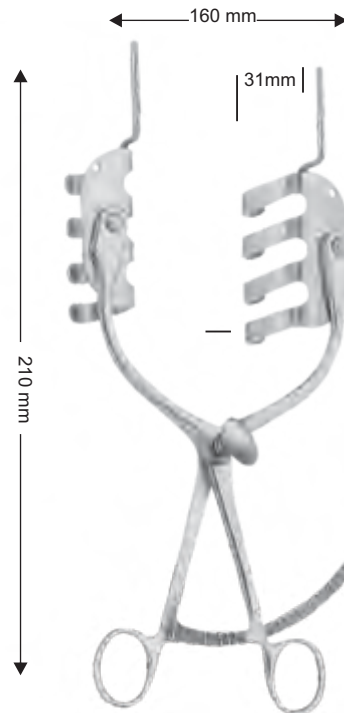

**ST MARKS HOSPITAL  
PERINEAL**  
210mm (8.3/8")

**3218**  
Blades: 70mm x 31mm

← 185mm →



**GOLIGHER  
3219**

Complete with two centre blades: 51mm deep, and four lateral blades:  
2 x 51mm deep  
2 x 102mm deep

← 190mm →

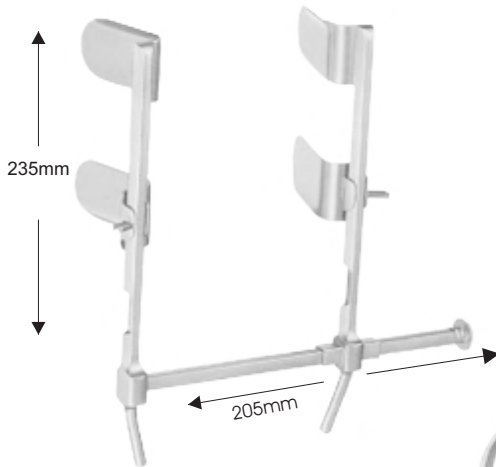

**BERKELEY ABDOMINAL  
3220**

Blades: 35mm x 60mm

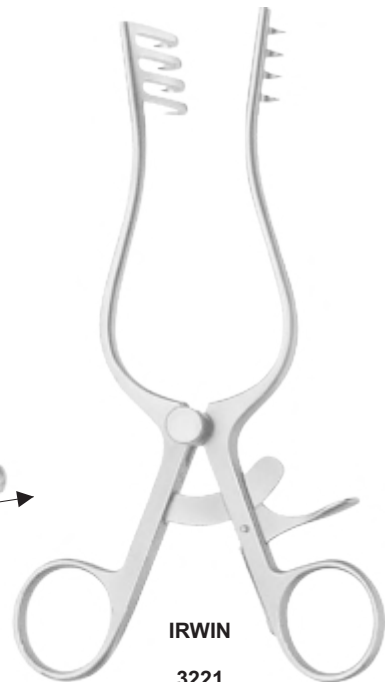

**IRWIN  
3221**

178mm (7")  
4 x 5 teeth  
Sharp



## TURNER WARWICK RETRACTOR BLADES



**3222**

Blade: 51mm x 38mm  
Curved, blackened finish

**3223**

Blade: 76mm x 60mm  
Curved, blackened finish



**3224**

Blade: 89mm x 60mm  
Flat, polished front  
surface

**3225**

Blade: 114mm x 60mm  
Flat polished front  
surface



**3226**

13mm deep  
Single hook  
blade

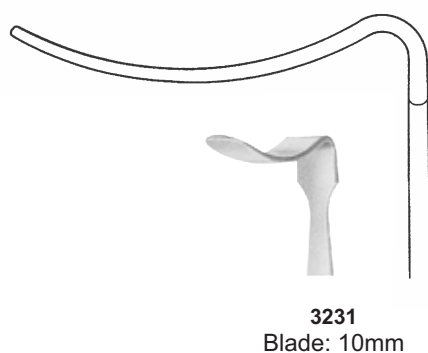
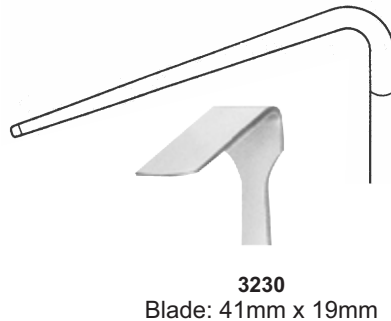
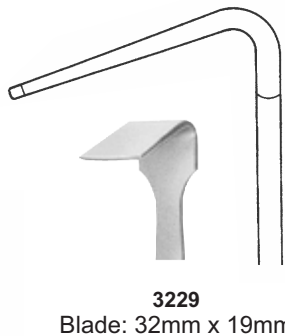
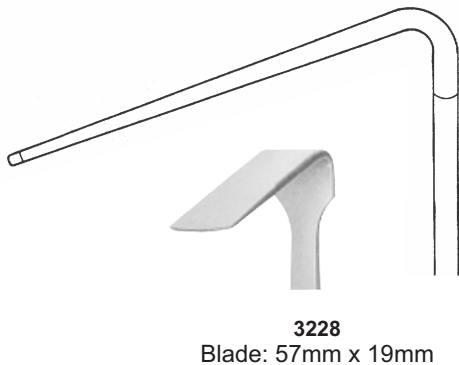
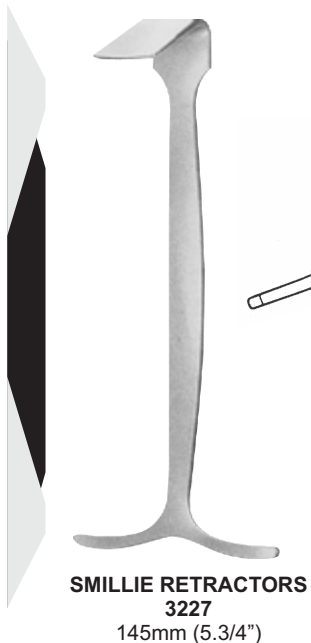

# Hand Held Retractors



## LLOYD DAVIS

**3233**

290mm (11.1/2")

Blade: 125mm x 60mm

End: 35mm x 45mm

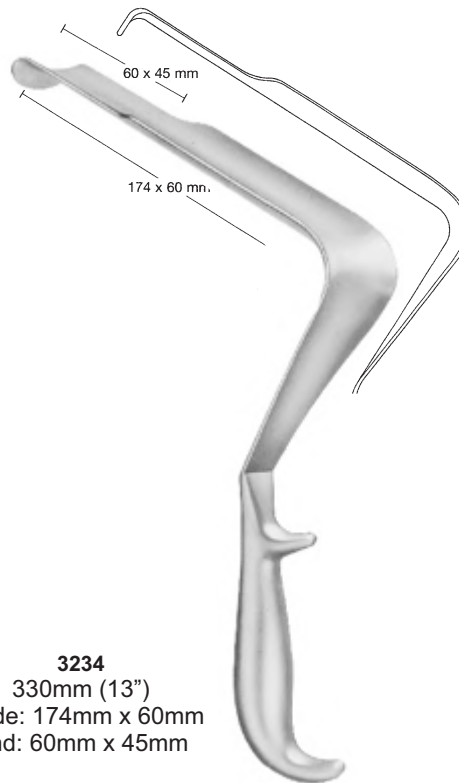

**3234**

330mm (13")

Blade: 174mm x 60mm

End: 60mm x 45mm



**ISRAEL**  
255mm (10")

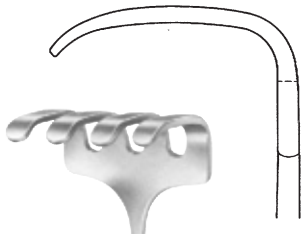

**3235**  
Blade: 39mm x 31mm  
Blunt



**3236**  
Blade: 47mm x 51mm  
Blunt

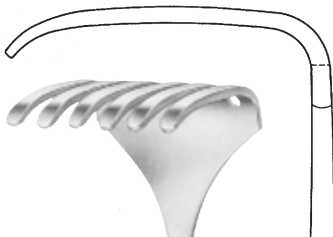

**3237**  
Blade: 53mm x 62mm  
Blunt

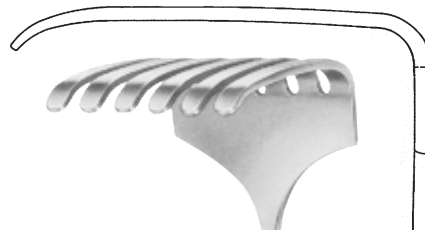

**3238**  
Blade: 70mm x 70mm  
Blunt

# Hand Held Retractors



3239



3241



3243



3245



3240



3242



3244



3246



165mm (6.1/2")  
Small curve sharp



165mm (6.1/2")  
Small curve blunt

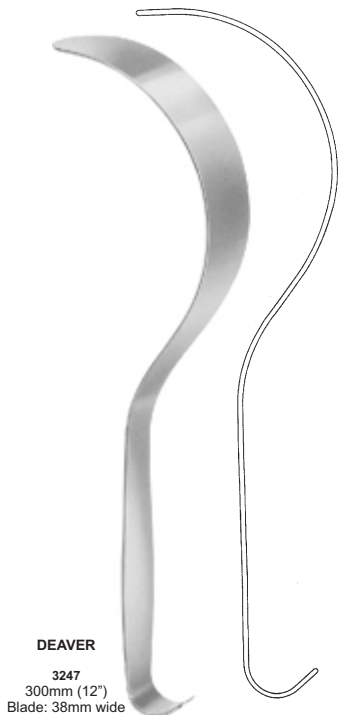

# Intestinal Clamps



**LANE TWIN ANASTOMOSIS**

**3250**  
300mm (12") Curved



**LANE TWIN ANASTOMOSIS**

**3251**  
300mm (12") Straight



**LLOYD DAVIS RECTAL OCCLUSION**

**3252**  
315mm (12.1/2")  
Angleg



**RESANO**

**3253**  
265mm (10.1/2")  
Colon resection clamp



## Intestinal Clamps

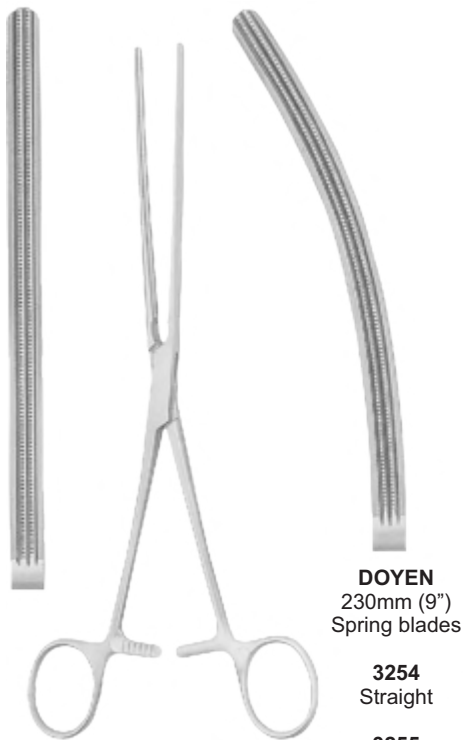

**DOYEN**  
230mm (9")  
Spring blades

**3254**  
Straight

**3255**  
Curved

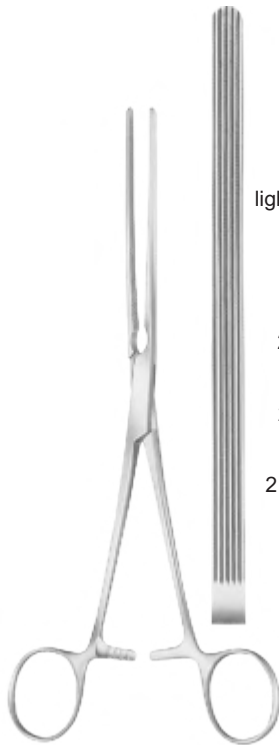

**DOYEN  
(KOCHER)**  
Straight,  
light spring blade

**3256**  
230mm (9")

**3257**  
232mm (10")

**3258**  
280mm (11")

**3259**  
210mm (8.1/4")

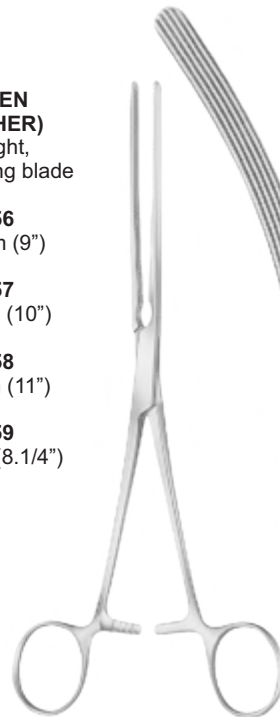

**DOYEN  
(MAYO ROBSON)**  
Curved,  
light spring blade

**3260**  
230mm (9")

**3261**  
232mm (10")

**3262**  
280mm (11")

**3263**  
210mm (8.1/4")

# Cervical Biopsy Forceps



**OVAL**  
7 x 5 mm

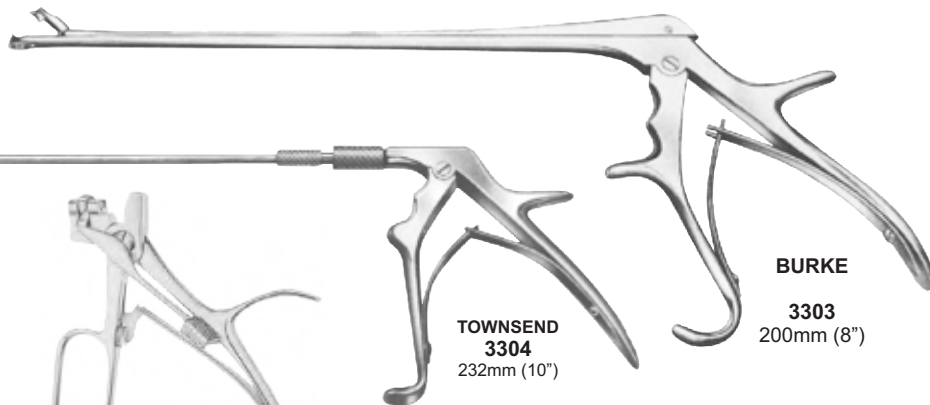

**TOWNSEND  
3304**  
232mm (10")

**BURKE**

**3303**  
200mm (8")



**3305**  
140mm (5.1/2")  
Pistol Grip



**3306**  
140mm (5.1/2")  
Pistol grip



**Shaft only**  
**3307** 200mm (8")  
**3308** 250mm (10")

Biopsy cutting



**3309** ⊕  
**3310** ⊕



**3311** ⊕



**3312** △



Fig.3

**OVAL**  
3.7 x 5mm



Fig.1

**TISHLER-MORGAN**



Fig.5

**MINI**



Fig.4

**KEVORKIAN**

# Bone Scoops

**VOLKMANN**  
Double ended  
**3322**  
130mm (5.1/8")  
**3323**  
131mm (5.1/2")  
**3324**  
170mm (6.3/4")



**MACEWEN**  
180mm (7")  
Combined with seeker  
**3325**  
Oval  
**3326**  
Round



**JACOBSON**  
**3327**  
131mm (5.1/2")



**MARTINI**  
**3328**  
131mm (5.1/2")



**MARTINI**  
**3329**  
131mm (5.1/2")



**LEMPERT**  
200mm (8")\*



**3330**  
2mm x 3.5mm



**3331**  
2mm x 4mm



**3332**  
2.5mm x 4.5mm



**3333**  
2.75mm x 5mm



**3334**  
3mm x 5.5mm



**3335**  
3.25mm x 6mm

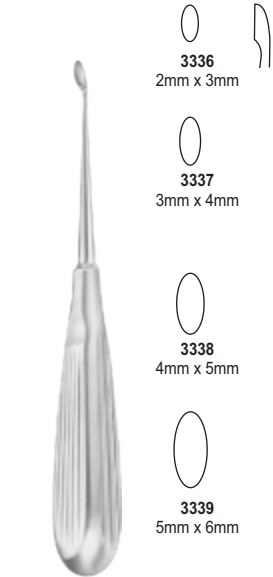

**COLLIER AND MORRIS**  
180mm (7")

**3336**  
2mm x 3mm



**3337**  
3mm x 4mm



**3338**  
4mm x 5mm



**3339**  
5mm x 6mm



# Bone Rongeurs





**HARTMANN**  
**3340**  
180mm (7")



**MEAD**  
**3341**  
165mm (6.1/2")



**NORTHFIELD**  
**3342**  
200mm (8")  
10mm bite



**SYNOVECTOMY RONGEUR**  
**3343**  
175mm (7")



## Bone & Rib Shears



**3352**  
230mm (9")



**3353**  
220mm (8.3/4")



**3354**  
170mm (6.3/4")



**GLUCK**  
**3355**  
220mm (8.3/4")



**GRAEME ANDERSON  
RECTAL SPECULUM  
3297**  
190mm (7.1/2")  
Diameter: 19mm



**SIMS RECTAL SPECULUM  
3298**  
160mm (6.1/4")



**CZERNY  
RECTAL SPECULUM  
3302**  
225mm (9")



**KELLY PROCTOSCOPE  
3299**  
140mm (5.1/2") Diameter, 22mm



**GABRIEL RECTAL SPECULUM  
3300**  
64mm (2.1/2")  
Diameter: 25mm



**PRATT RECTAL SPECULUM  
3301**  
205mm (8")



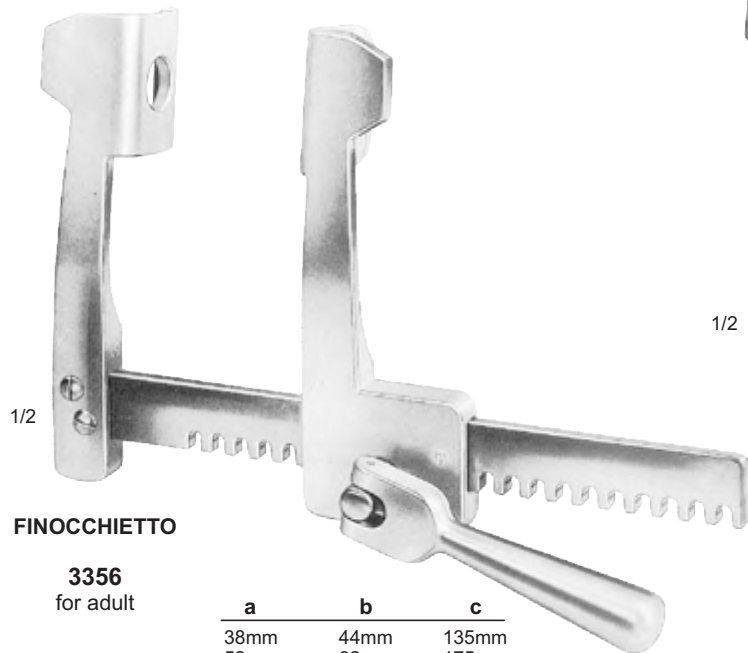

**FINOCCHIETTO**

**3356**  
for adult

a	b	c
38mm	44mm	135mm
52mm	62mm	175mm
85mm	65mm	175mm



**FINOCCHIETTO-BABY**

**3357**  
Child size

a	b	c
31mm	31mm	100mm

# Atrauma Hemostatic/Cardiovascular Forceps

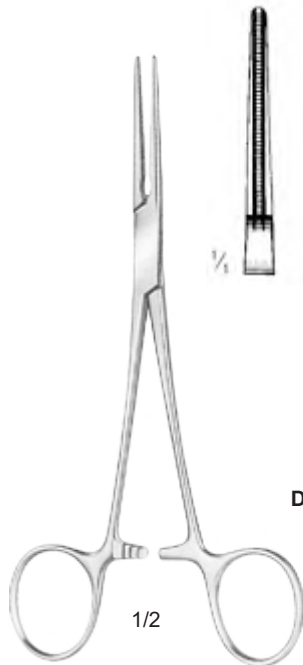

**DE BAKEY-RANKIN**

**3358**

Straight  
160mm (6.1/4")

**3359**

Curved  
160mm (6.1/4")

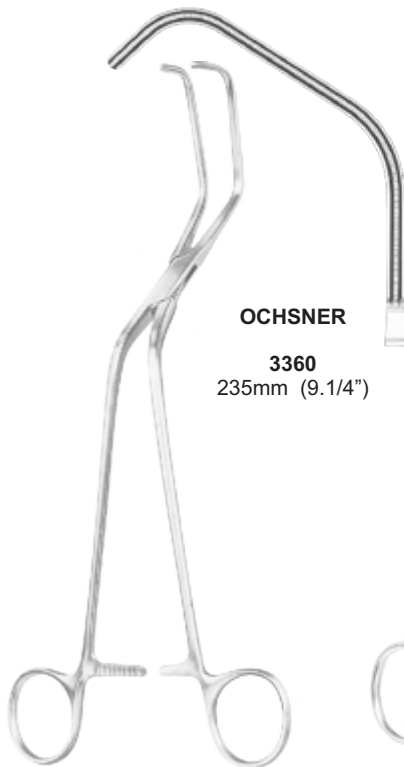

**OCHSNER**

**3360**

235mm (9.1/4")

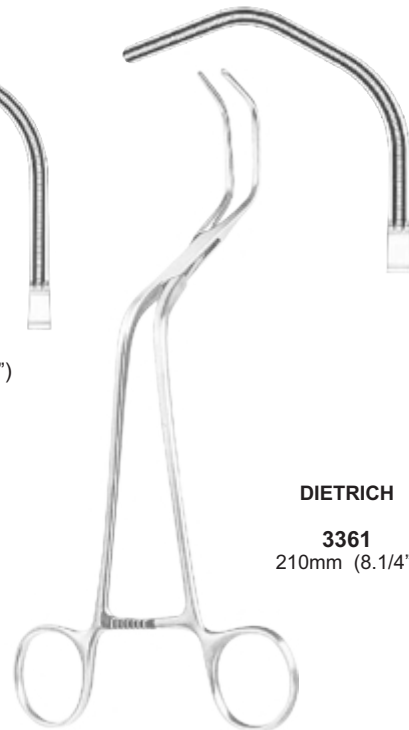

**DIETRICH**

**3361**

210mm (8.1/4")

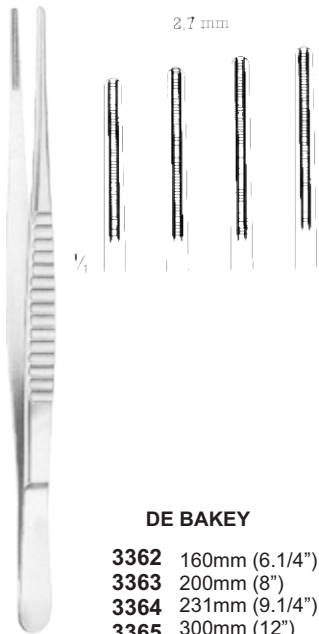

**DE BAKEY**

- 3362** 160mm (6.1/4")
- 3363** 200mm (8")
- 3364** 231mm (9.1/4")
- 3365** 300mm (12")

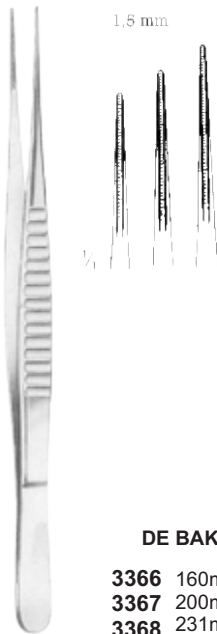

**DE BAKEY**

- 3366** 160mm (6.1/4")
- 3367** 200mm (8")
- 3368** 231mm (9.1/4")

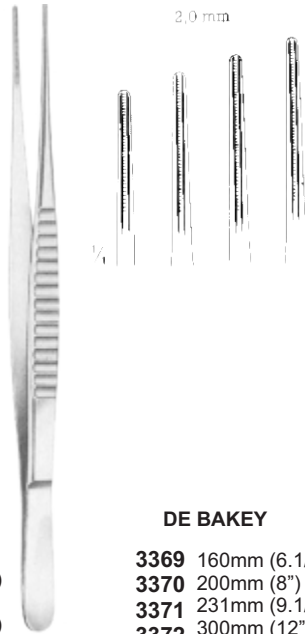

**DE BAKEY**

- 3369** 160mm (6.1/4")
- 3370** 200mm (8")
- 3371** 231mm (9.1/4")
- 3372** 300mm (12")



**COOLEY**

- 3373** 160mm (6.1/4")
- 3374** 200mm (8")

# Scalpel Handles



**Scalpel Handles**  
4159  
Fig. 5A



**Scalpel Handles**  
4160  
Fig. 5



**Scalpel Handles**  
4161  
Fig. 7



**Scalpel Handles**  
4162  
Fig. 8



**Scalpel Handles**  
4163  
Fig-3G



**Scalpel Handles**  
4164  
Fig-3

**Mikulicz**  
037-09664  
180mm (7")



**Mikulicz**  
037-09665  
205mm (8")



**Peritoneum**  
037-09666  
205mm (8")



## Peritoneum Instruments



**Peritoneum**  
O37-09667  
205mm (8")



**Faure**  
O37-09668  
205mm (8")



**Faure**  
O37-09669  
205mm (8")



**BALLAND SOCKET**  
TC-3475  
130mm 5"

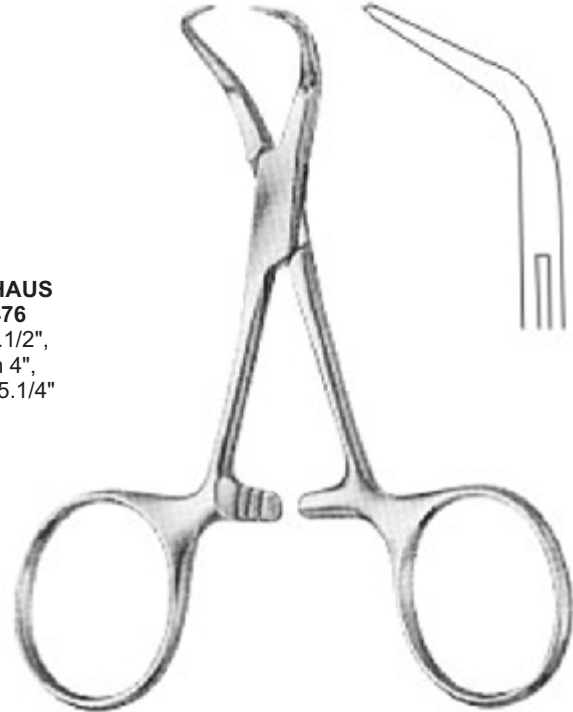

**BACKHAUS**  
TC-3476  
90mm 3.1/2",  
100mm 4",  
135mm 5.1/4"

## Towel Clamps

**MAYO**  
**TC-3479**  
140mm 5.1/2"

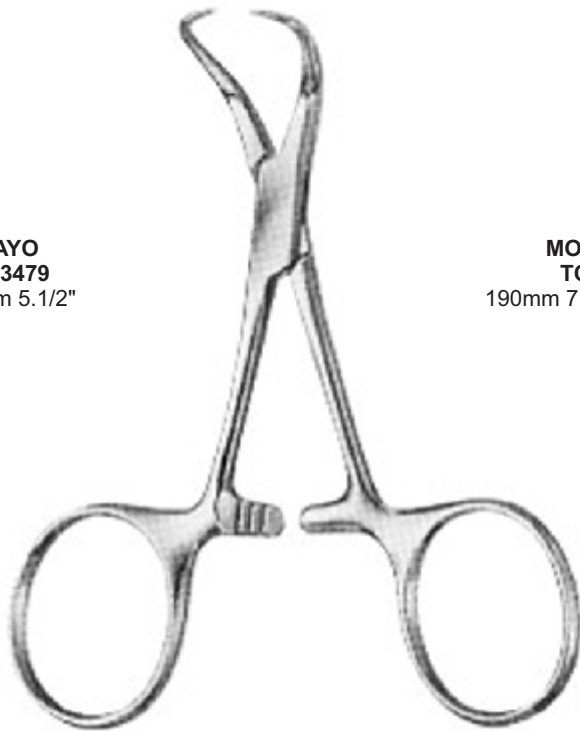

**MOYNIHAN**  
**TC-3480**  
190mm 7.1/2" 2x2 teeth

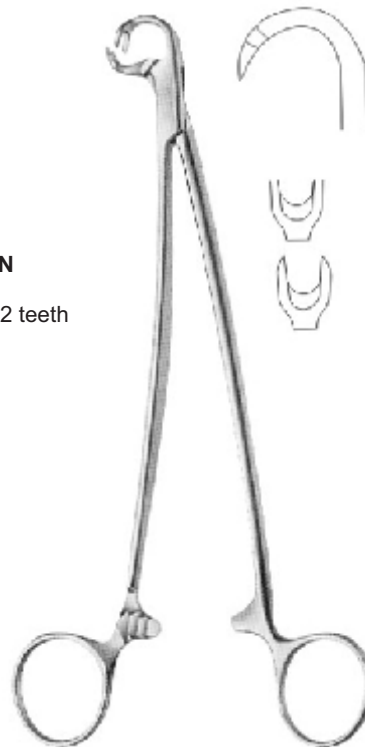



**RAMPLEY**  
SHF-3465  
180mm 7", 240mm 9.1/2"

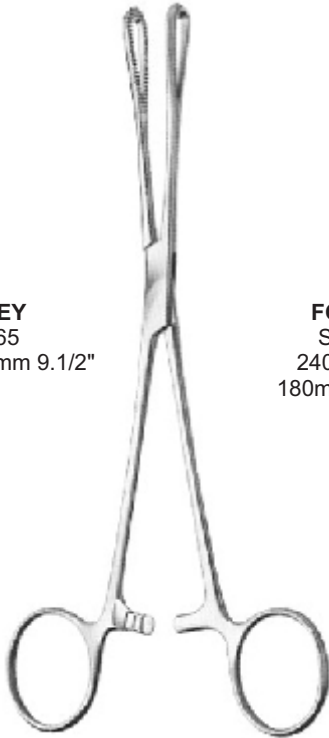

**FORESTER**  
SHF-3467  
240mm 9.1/2",  
180mm 7" Straight



**FORESTER**  
SHF-3469  
240mm 9.1/2",  
180mm 7"  
Curved on flat



# Tubing Clamps

**Mohr Pinchcocks**  
**TC-50-101**  
Width 80 mm

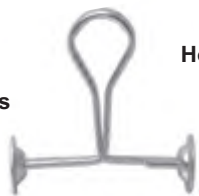

**Hoffmann Tubing Clamp**  
**TC-50-107**  
Satin Finish  
Width 30 mm

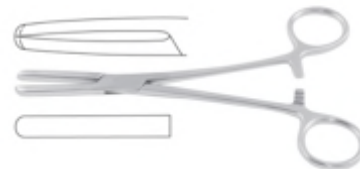

**Presbyterian Tubing Clamp**  
**TC-50-119**  
18 cm - 7"  
16.5 cm - 6 1/2"



**Klinikum Berlin Tubing Clamp**  
**TC-50-121**  
Klinikum Berlin Tubing Clamp  
Extra Long Ratchet 14 cm - 5 1/2"



**Tubing Clamps**  
**10-001-25**  
With Protector 15 cm  
18 cm - 20 cm



**Tubing Clamps**  
**10.0015.25**  
15 cm  
18 cm  
20 cm